



**INTERCONNECTION
FACILITIES STUDY
REPORT**

GEN-2017-133

Published April 2023

By SPP Generator Interconnections Dept.

REVISION HISTORY

DATE OR VERSION NUMBER	AUTHOR	CHANGE DESCRIPTION
04/12/2023	SPP	Initial draft report issued.
05/02/2023	SPP	Updated upgrade information and cost for UIDs 156445 & 156471 in Table 3.
05/18/2023	SPP	Revision to costs of UIDs 156856, 156854, & 156853 in Table 3.
06/05/2023	SPP	Final report issued.

CONTENTS

Revision History	i
Summary	1
Introduction	1
Phase(s) of Interconnection Service	1
Compensation for Amounts Advanced for Network Upgrade(s).....	1
Interconnection Customer Interconnection Facilities	2
Transmission Owner Interconnection Facilities and Non-Shared Network Upgrade(s).....	3
Shared Network Upgrade(s)	3
Contingent Network Upgrade(s).....	5
Affected System Upgrade(s)	6
Conclusion.....	7
Appendices	8
A: Transmission Owner’s Interconnection Facilities Study Report and Network Upgrades Report(s).....	1

SUMMARY

INTRODUCTION

This Interconnection Facilities Study (IFS) for Interconnection Request is for a 200 MW generating facility located in Oklahoma, OK. The Interconnection Request was studied in the DISIS-2017-002 Impact Study for ERIS. The Interconnection Customer's requested in-service date is December 01, 2027.

The interconnecting Transmission Owner, Oklahoma Gas & Electric Company (OGE), performed a detailed IFS at the request of SPP. The full report is included in Appendix A. SPP has determined that full Interconnection Service will be available after the assigned Transmission Owner Interconnection Facilities (TOIF), Non-Shared Network Upgrades, Shared Network Upgrades, Contingent Network Upgrades, and Affected System Upgrades that are required for full interconnection service are completed.

The primary objective of the IFS is to identify necessary Transmission Owner Interconnection Facilities, Network Upgrades, other direct assigned upgrades, cost estimates, and associated upgrade lead times needed to grant the requested Interconnection Service.

PHASE(S) OF INTERCONNECTION SERVICE

It is not expected that Interconnection Service will occur in phases. However, full Interconnection Service will not be available until all Interconnection Facilities and Network Upgrade(s) can be placed in service.

COMPENSATION FOR AMOUNTS ADVANCED FOR NETWORK UPGRADE(S)

FERC Order ER20-1687-000 eliminated the use of Attachment Z2 revenue crediting as an option for compensation. The Incremental Long Term Congestion Right (ILTCR) process will be the sole process to compensate upgrade sponsors as of July 1st, 2020.

INTERCONNECTION CUSTOMER INTERCONNECTION FACILITIES

The Generating Facility is proposed to consist of (100) General Electric 2.0 wind turbines for a total generating nameplate capacity of 200 MW.

The Interconnection Customer's Interconnection Facilities to be designed, procured, constructed, installed, maintained, and owned by the Interconnection Customer at its sole expense include:

34.5 kV underground cable collection circuits;

34.5 kV to 345 kV transformation substation with associated 34.5 kV and 345 kV switchgear;

One 345/34.5 kV 135/180/225 MVA (ONAN/ONAF/ONAF) step-up transformer to be owned and maintained by the Interconnection Customer at the Interconnection Customer's substation;

Approx. 228 miles 345 kV line to connect the Interconnection Customer's substation to the Point of Interconnection ("POI") at the 345 kV bus at existing Transmission Owner substation ("Arcadia 345kV") that is owned and maintained by Transmission Owner;

All transmission facilities required to connect the Interconnection Customer's substation to the POI;

Equipment at the Interconnection Customer's substation necessary to maintain a composite power delivery at continuous rated power output at the high-side of the generator substation at a power factor within the range of 95% lagging and 95% leading in accordance with Federal Energy Regulatory Commission (FERC) Order 827. The Interconnection Customer may use inverter manufacturing options for providing reactive power under no/reduced generation conditions. The Interconnection Customer will be required to provide documentation and design specifications demonstrating how the requirements are met; and,

All necessary relay, protection, control and communication systems required to protect Interconnection Customer's Interconnection Facilities and Generating Facilities and coordinate with Transmission Owner's relay, protection, control and communication systems.

TRANSMISSION OWNER INTERCONNECTION FACILITIES AND NON-SHARED NETWORK UPGRADE(S)

To facilitate interconnection, the interconnecting Transmission Owner will perform work as shown below necessary for the acceptance of the Interconnection Customer’s Interconnection Facilities.

Table 1 and **Table 2** lists the Interconnection Customer’s estimated cost responsibility for Transmission Owner Interconnection Facilities (TOIF) and Non-Shared Network Upgrade(s) and provides an estimated lead time for completion of construction. The estimated lead time begins when the Generator Interconnection Agreement has been fully executed.

Table 1: Transmission Owner Interconnection Facilities (TOIF)

Transmission Owner Interconnection Facilities (TOIF)	Total Cost Estimate (\$)	Allocated Percent (%)	Allocated Cost Estimate (\$)	Estimated Lead Time
<u>Arcadia 345kV GEN-2017-133 Interconnection (TOIF) (OGE) (143379):</u> <u>Interconnection upgrades and cost estimates needed to interconnect the following Interconnection Customer facility, GEN-2017-133 (200 MW/Wind), into the Point of Interconnection (POI) at Arcadia 345kV</u>	\$397,914	100%	\$397,914	36 Months
Total	\$397,914		\$397,914	

Table 2: Non-Shared Network Upgrade(s)

Non-Shared Network Upgrades Description	ILTCR	Total Cost Estimate (\$)	Allocated Percent (%)	Allocated Cost Estimate (\$)	Estimated Lead Time
<u>NA</u>	NA	NA	NA	NA	NA
Total		NA		NA	

SHARED NETWORK UPGRADE(S)

The Interconnection Customer’s share of costs for Shared Network Upgrades is estimated in table below.

Table 3: Interconnection Customer Shared Network Upgrade(s)

Shared Network Upgrades Description	ILTCR	Total Cost Estimate (\$)	Allocated Percent (%)	Allocated Cost Estimate (\$)	Estimated Lead Time
<p><u>Arcadia 345kV Interconnection Expansion (DISIS-2017-002) (143376):</u> <u>Expand the Arcadia 345kV substation to accommodate the interconnection of GEN-2017-132, GEN-2017-133, GEN-2017-134, GEN-2017-137</u></p>	Eligible	\$11,894,705	17.47%	\$2,077,677.73	36 Months
<p><u>New 345/138 kV Transformer at Arcadia (Transformer #4) (156856):</u> <u>Build a fourth 345/138 kV transformer at Arcadia Substation</u></p>	Eligible	\$16,002,856	17.47%	\$2,795,258.69	36 Months
<p><u>Renfrow 345 kV Terminal Equipment Upgrade (DISIS-2017-002) (OGE)(156445):</u> <u>Upgrade terminal equipment at point of change (OK/KS State Line) to accept Viola 345 kV line rebuild to achieve minimum summer/emergency rating of 1195 MVA.</u></p>	Eligible	\$250,000	3.56%	\$8,899.90	36 Months
<p><u>Viola to Renfrow 345 kV Rebuild (WERE) (DISIS-2017-002) (156471):</u> <u>Rebuild the existing Viola to Renfrow 345 kV line from Viola to the OK/KS State Line (23 miles) to achieve a minimum summer/emergency rating of 1195 MVA</u></p>	Eligible	\$47,418,633	3.56%	\$1,688,084.16	36 Months
<p><u>Arcadia to Jinskamo 138 kV Rebuild (DISIS-2017-002)(156854):</u> <u>Rebuild the Arcadia to Jinskamo 138 kV 6.67 mile line to achieve a min Winter emergency rating of 375 MVA and a min Summer emergency rating of 361 MVA</u></p>	Eligible	\$8,375,000	17.47%	\$1,462,882.10	30 Months

<u>Arcadia to Edmond Garber Lake 138 kV Rebuild (DISIS-2017-002)(156853):</u> Rebuild the Arcadia to Edmond Garber Lake 138 kV 4.77 mile line to achieve a min Winter emergency rating of 375 MVA and a min Summer rating of 313 MVA	Eligible	\$6,000,000	17.47%	\$1,048,034.93	36 Months
Total		\$89,941,194.00		\$9,080,837.51	

All studies have been conducted assuming that higher-queued Interconnection Request(s) and the associated Network Upgrade(s) will be placed into service. If higher-queued Interconnection Request(s) withdraw from the queue, suspend or terminate service, the Interconnection Customer’s share of costs may be revised. Restudies, conducted at the customer’s expense, will determine the Interconnection Customer’s revised allocation of Shared Network Upgrades.

CONTINGENT NETWORK UPGRADE(S)

Certain Contingent Network Upgrades are **currently not the cost responsibility** of the Interconnection Customer but will be required for full Interconnection Service.

Table 3: Interconnection Customer Contingent Network Upgrade(s)

Contingent Network Upgrade(s) Description	Current Cost Assignment	Estimated In-Service Date
<u>NA</u>	<u>NA</u>	<u>NA</u>

Depending upon the status of higher- or equally-queued customers, the Interconnection Request’s in-service date is at risk of being delayed or Interconnection Service is at risk of being reduced until the in-service date of these Contingent Network Upgrades.

AFFECTED SYSTEM UPGRADE(S)

To facilitate interconnection, the Affected System Transmission Owner will be required to perform the facilities study work as shown below necessary for the acceptance of the Interconnection Customer’s Interconnection Facilities. **Table 5** displays the current impact study costs provided by either MISO or AECI as part of the Affected System Impact review. The Affected System facilities study could provide revised costs and will provide each Interconnection Customer’s allocation responsibilities for the upgrades.

Table 4: Interconnection Customer Affected System Upgrade(s)

Affected System Upgrades Description	Total Cost Estimate (\$)	Allocated Percent (%)	Allocated Cost Estimate (\$)
<u>NA</u>	NA	NA	NA
Total	NA		NA

CONCLUSION

After all Interconnection Facilities and Network Upgrades have been placed into service, Interconnection Service for MW can be granted. Full Interconnection Service will be delayed until the TOIF, Non-Shared NU, Shared NU, Contingent NU, Affected System Upgrades that are required for full interconnection service are completed. The Interconnection Customer’s estimated cost responsibility for full interconnection service is summarized in the table below.

Table 5: Cost Summary

Description	Allocated Cost Estimate
Transmission Owner Interconnection Facilities Upgrade(s)	\$397,914
Non-Shared Network Upgrade(s)	\$0
Shared Network Upgrade(s)	\$9,080,837.51
Affected System Upgrade(s)	\$0
Total	\$9,478,751.51

Use the following link for Quarterly Updates on upgrades from this report: <https://spp.org/spp-documents-filings/?id=18641>

A draft Generator Interconnection Agreement will be provided to the Interconnection Customer consistent with the final results of this IFS report. The Transmission Owner and Interconnection Customer will have 60 days to negotiate the terms of the GIA consistent with the SPP Open Access Transmission Tariff (OATT).

APPENDICES

**A: TRANSMISSION OWNER'S INTERCONNECTION FACILITIES STUDY REPORT
AND NETWORK UPGRADES REPORT(S)**

See next page for the Transmission Owner's Interconnection Facilities Study Report and Network Upgrades Report(s).



Interconnection Facilities Study

Network Upgrades associated with DISIS-2017-002

March 2023

Introduction

This report summarizes the scope of the Interconnection Facilities Analysis for Network Upgrade(s) to determine costs related to the addition of the SPP-GI DISIS-2017-002 Interconnection Request(s).

Southwest Power Pool Generation Interconnection Request:

Per the SPP Generator Interconnection Procedures (GIP), SPP has requested that Evergy perform an Interconnection Facilities Study (IFS) for Network Upgrade(s) in accordance with the Scope of Interconnection Facilities Study GIP Section 8.10 and the Interconnection Facilities Study Procedures in accordance with GIP Section 8.11 for the following Interconnection Request(s):

Upgrade Type	UID	Upgrade Name	DISIS Cost	DISIS Lead Time
Network Upgrade	156516	Archie 161 kV Terminal Upgrades (DISIS-2017-002) (EMW)	\$1,455,934	36 Months
Network Upgrade	156851	Archie – G17-108 Tap 161 kV Rebuild (DISIS-2017-002) (EMW)	\$41,157,960	36 Months
Network Upgrade	156461	Craig to Lenexa 161 kV Double Circuit Rebuild (DISIS-2017-002) (EM)	\$8,294,859	36 Months
Network Upgrade	156457	Post Oak 69-35 kV Transformer Replacement (DISIS-2017-002) (EKC)	\$2,470,058	36 Months
Network Upgrade	156471	Viola to G17-185 Tap 345 kV Line Rebuild (DISIS-2017-002) (EKC)	\$47,418,635	36 Months

Archie 161 kV Terminal Upgrades 161

kV Substation

All terminal equipment to be replaced to meet a 2000 Amp rating. This will require a main bus rebuild to 4" aluminum pipe bus and includes bus side disconnects for the other three line terminals.

Total Cost

The total cost estimate for this Network Upgrade is:

\$	0	161kV Transmission Line
\$	1,451,579	161kV Substation
\$	4,354	AFUDC
\$	0	Contingency
\$	1,455,934	Total

This estimate is accurate to +/- twenty (20) percent, based on current prices, in accordance with Attachment A of Appendix 4 of the Interconnection Facilities Study Agreement.

However, recent cost fluctuations in materials are very significant and the accuracy of this estimate at the time of actual settings cannot be assured.

Time Estimate

Time estimates are based on current version of the project schedule and some processes of each category run concurrently.

Engineering Time	12-18	Months
Procurement Time	12-18	Months
Construction Time	12	Months
Total Project Length	36-48	Months

Figure 1 – Archie 161 kV Sub

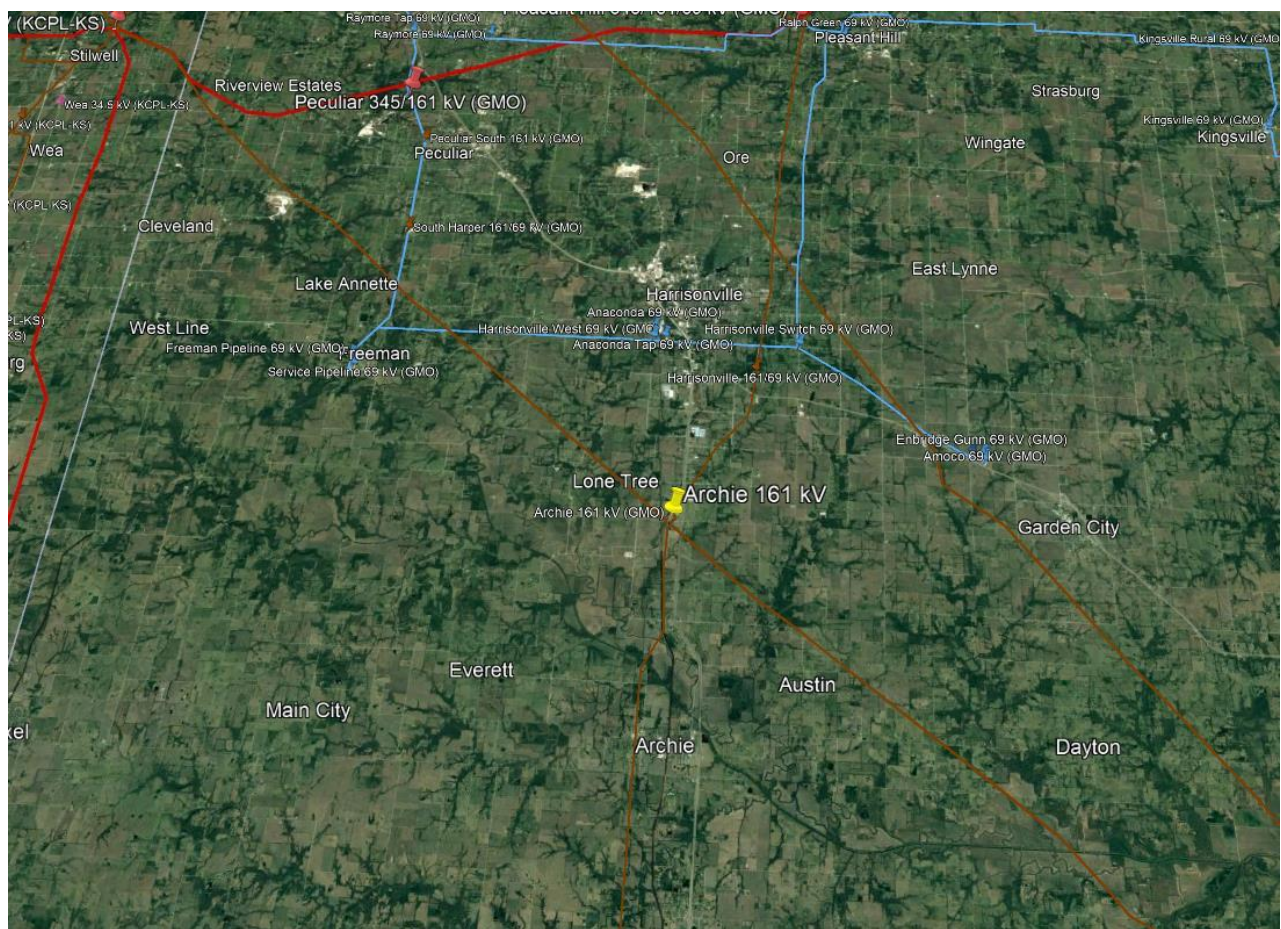

Archie – G17-108 Tap 161 kV Rebuild 161

kV Transmission Line

The estimated cost is for 28.73 miles of 161kV circuit. Line will be rebuilt using steel structures, with angles and dead-ends on drilled piers. Estimate assumes the conductor will be 1192 ACSS/TW and OPGW will be installed.

Total Cost

The total cost estimate for this Network Upgrade is:

\$	39,783,750	161 kV Transmission Line
\$	0	161 kV Substation
\$	1,374,210	AFUDC
\$	0	Contingency
<hr/>		
\$	41,157,960	Total

This estimate is accurate to +/- twenty (20) percent, based on current prices, in accordance with Attachment A of Appendix 4 of the Interconnection Facilities Study Agreement. However, recent cost fluctuations in materials are very significant and the accuracy of this estimate at the time of actual settings cannot be assured.

Time Estimate

Time estimates are based on current version of the project schedule and some processes of each category run concurrently.

Engineering Time	12-18	Months
Procurement Time	12-18	Months
Construction Time	12	Months
<hr/>		
Total Project Length	36-48	Months

Figure 2 – Archie – G17-108 Tap

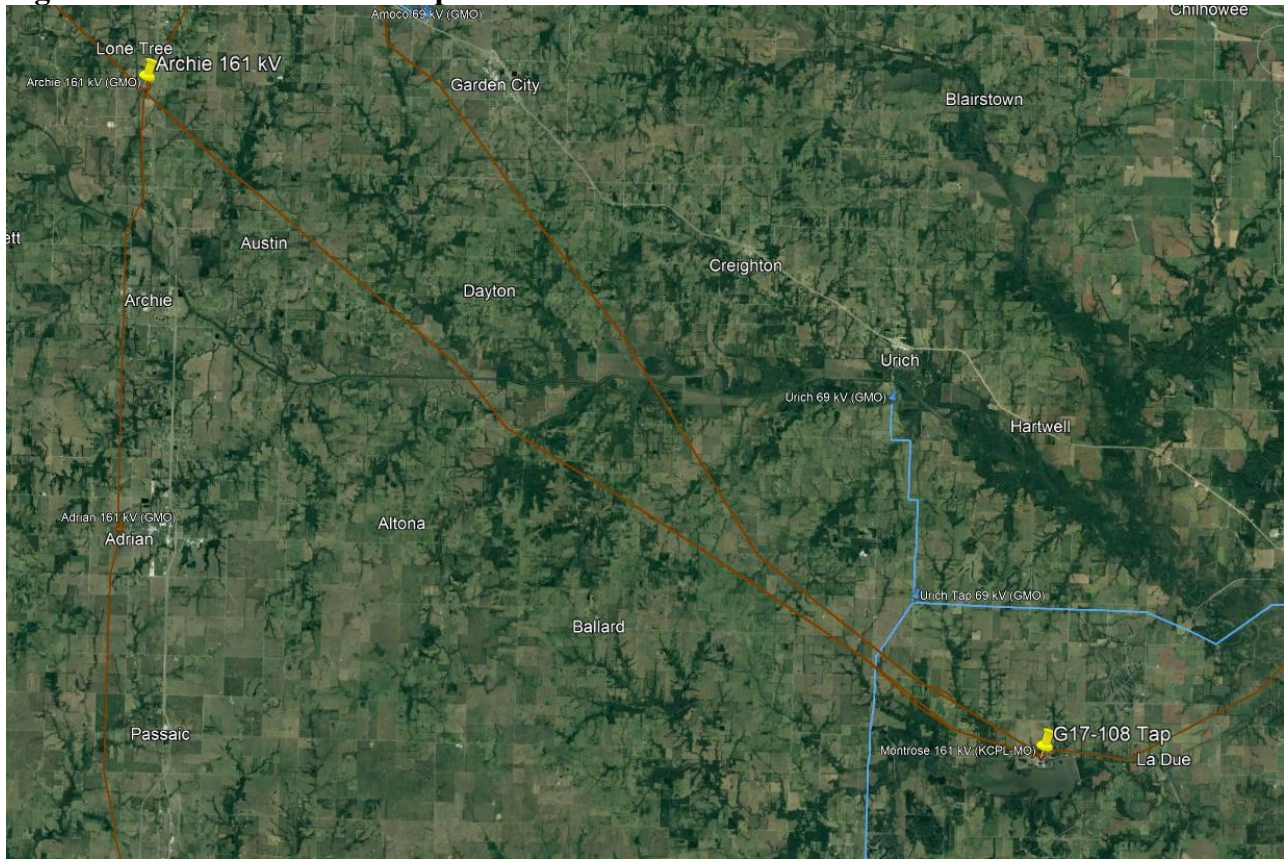

Craig to Lenexa 161 kV Double Circuit Rebuild 161 kV

Transmission Line

The estimated cost is for 2.95 miles of 161kV double circuit. The lines will be rebuilt with steel structures, 1192 ACSS/TW conductor and two OPGW's designed to Evergy standards.

Total Cost

The total cost estimate for this Network Upgrade is:

\$	7,763,088	161 kV Transmission Line
\$	0	161 kV Substation
\$	531,771	AFUDC
\$	0	Contingency
<hr/>		
\$	8,294,859	Total

This estimate is accurate to +/- twenty (20) percent, based on current prices, in accordance with Attachment A of Appendix 4 of the Interconnection Facilities Study Agreement. However, recent cost fluctuations in materials are very significant and the accuracy of this estimate at the time of actual settings cannot be assured.

Time Estimate

Time estimates are based on current version of the project schedule and some processes of each category run concurrently.

Engineering Time	12-18	Months
Procurement Time	12-18	Months
Construction Time	12	Months
<hr/> Total Project Length	<hr/> 36-48	<hr/> Months

Figure 3 – Craig – Lenexa 161kV Line

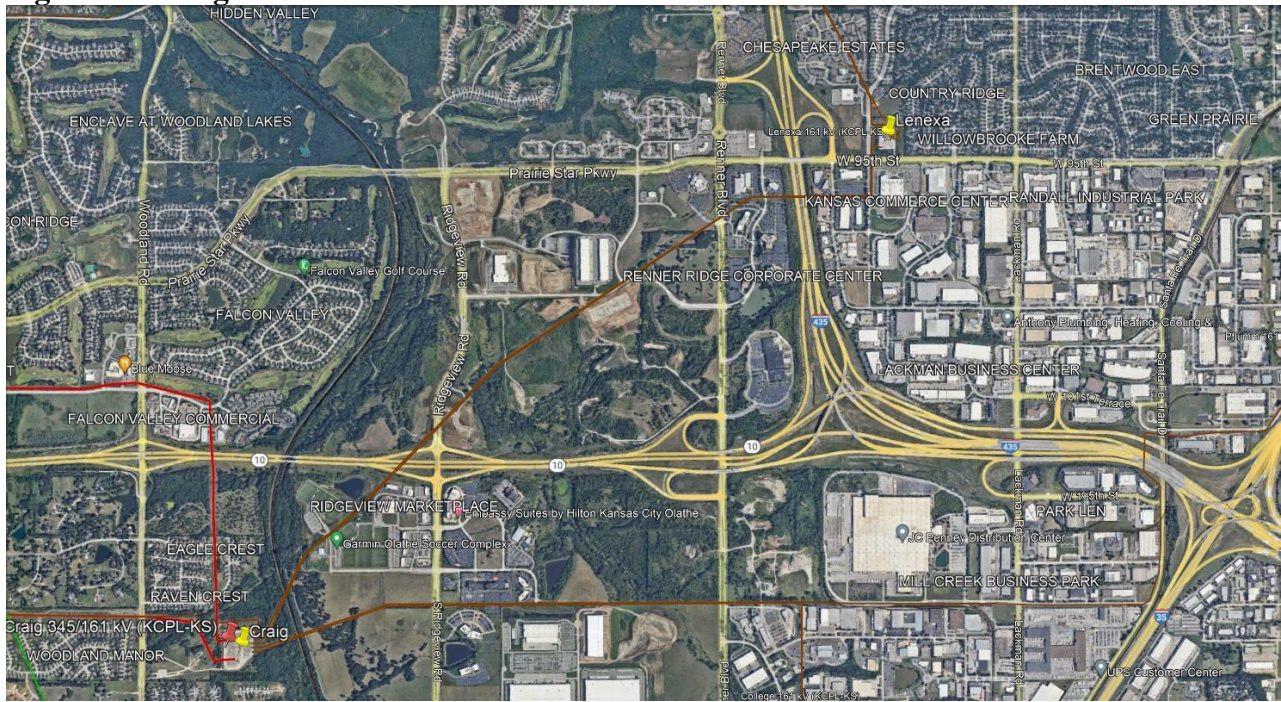

Post Oak 69-35 kV Transformer Replacement

69 kV Transformer

Replace Post Oak 69/35 kV Transformer with a 50MVA 69/34kV Transformer. This will also require a 34kV bank breaker, 34kV feeder breaker, box bay, RTU, control house and metering equipment.

Total Cost

The total cost estimate for this Network Upgrade is:

\$	2,462,670	69 kV Substation Transformer
\$	7,388	AFUDC
\$	0	Contingency
<hr/>		
\$	2,470,058	Total

This estimate is accurate to +/- twenty (20) percent, based on current prices, in accordance with Attachment A of Appendix 4 of the Interconnection Facilities Study Agreement. However, recent cost fluctuations in materials are very significant and the accuracy of this estimate at the time of actual settings cannot be assured.

Time Estimate

Time estimates are based on current version of the project schedule and some processes of each category run concurrently.

Engineering Time	12-18	Months
Procurement Time	12-18	Months
Construction Time	12	Months
<hr/>		
Total Project Length	36-48	Months

Figure 4 – Post Oak – 69kV Transformer



Viola – Renfrow 345 kV Rebuild (Evergy Portion)

345 kV Transmission Line

The estimated cost is for the rebuild of the 23-mile Evergy portion of the Viola – Renfrow 345kV line to meet a 3000 Amp line rating. Line will be rebuilt using steel structures, with angles and dead-ends on drilled piers. Estimate assumes the conductor will be 1590 Lapwing ACSR and OPGW will be installed.

Total Cost

The total cost estimate for this Network Upgrade is:

\$	47,276,805	345 kV Transmission Line
\$	0	345 kV Substation
\$	141,830	AFUDC
\$	0	Contingency
\$	47,418,635	Total

This estimate is accurate to +/- twenty (20) percent, based on current prices, in accordance with Attachment A of Appendix 4 of the Interconnection Facilities Study Agreement. However, recent cost fluctuations in materials are very significant and the accuracy of this estimate at the time of actual settings cannot be assured.

Time Estimate

Time estimates are based on current version of the project schedule and some processes of each category run concurrently.

Engineering Time	12-18	Months
Procurement Time	12-18	Months
Construction Time	12	Months
<u>Total Project Length</u>	<u>36-48</u>	<u>Months</u>

Figure 5 – Viola – Renfrow 345 kV

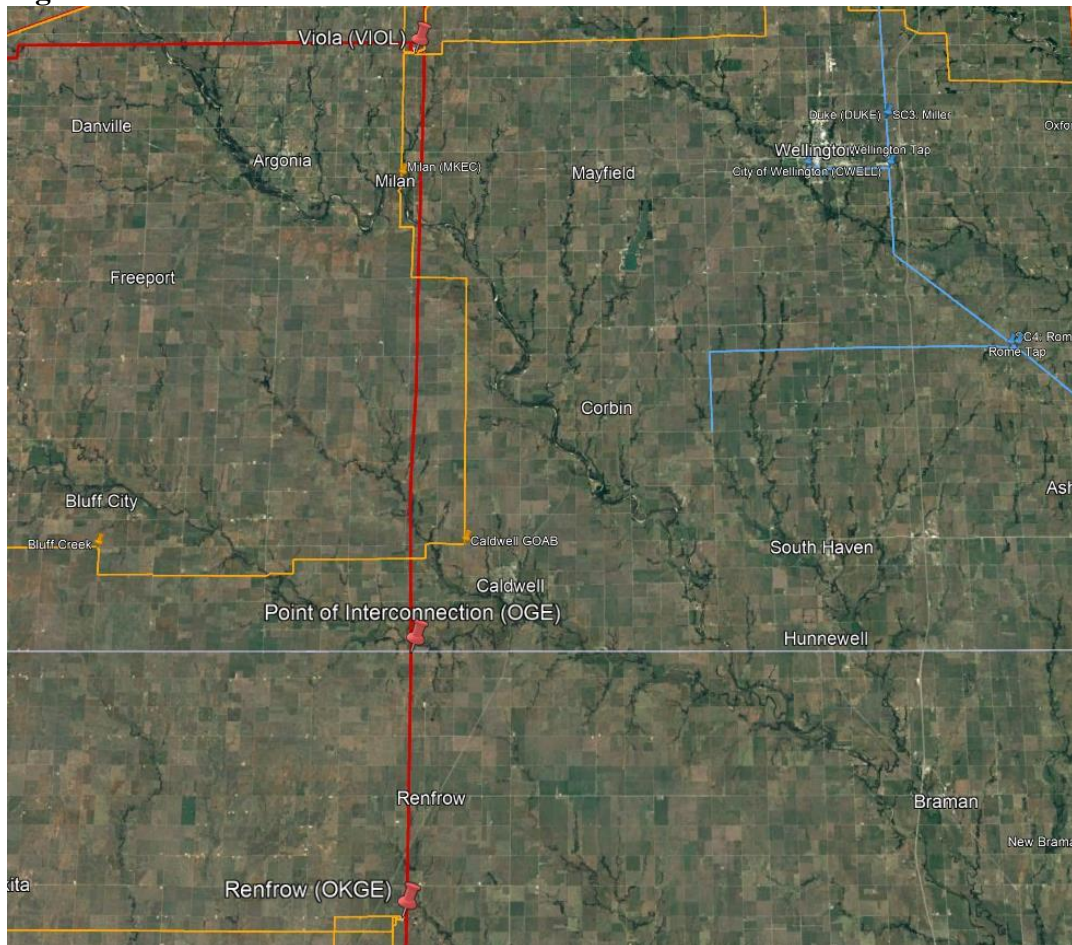



FACILITY STUDY

for

Generation Interconnection Request 2017-133

200 MW Wind Generating Facility
In Oklahoma County
Oklahoma

March 9, 2023

Chris Rich, P.E.
Transmission Planning Engineer
OG&E Electric Services

Summary

Pursuant to the tariff and at the request of the Southwest Power Pool (SPP), Oklahoma Gas and Electric (OG&E) performed the following Facility Study to satisfy the Facility Study Agreement executed by the requesting customer for SPP Generation Interconnection request Gen-2017-133. The request for interconnection was placed with SPP in accordance SPP's Open Access Transmission Tariff, which covers new generation interconnections on SPP's transmission system. The requirements for interconnection consist of adding two 345kV breakers, a line reactor, and a new line terminal for a new Wind farm at Arcadia 345kV Substation. This interconnection is shared among Gen-2017-132, Gen-2017-133, Gen-2017-134 and Gen-2017-137. Since these four requests will share the same Gen-tie line and are a part of the same DISIS study group, costs for the total project will be divided equally among the four projects. If one GIA request is withdrawn or delayed for whatever reason, the GIA request(s) that move forward will be assumed to cover the remaining costs of the project. In addition, an engineering EMTP study will need to be completed. Costs for any mitigation steps taken due to EMTP study results will need to be added to the facility study's estimate. The 345kV Arcadia sub will need to be expanded two rungs and to move the Arcadia – Seminole line to the new terminal location and bring the new gen tie line into the terminal currently occupied by Seminole. The portion of total cost allocated to this GIA request for OKGE to expand the sub, add two 345kV breakers, a line reactor, a new line terminal for a new wind generating facility, move the Arcadia – Seminole line and have an EMTP study at Arcadia 345kV substation, the interconnection facility, is estimated at \$13,486,359.

Table of Contents

Table of Contents	3
Introduction	4
Interconnection Facilities	5
Interconnection Costs	6
One-Line diagram of Interconnection	7

Introduction

The Southwest Power Pool has requested a Facility Study for the purpose of interconnecting a Wind farm facility within the service territory of OG&E Electric Services (OKGE) in Oklahoma County, Oklahoma. The proposed 345kV point of interconnection is at Arcadia Substation near Arcadia, Oklahoma. This substation is owned by OKGE. The cost of adding a new 345kV terminal to Arcadia Substation, the required interconnection facility for Gen-2017-133 is estimated at \$1,591,654.

Network Constraints in the Southwest Public Service (SPS), OKGE and Western Farmers Electric Cooperative (WFEC) systems may be verified with a transmission service request and associated studies.

Other Network Constraints in the American Electric Power West (AEPW), Southwest Public Service (SPS), OKGE and Western Farmers Electric Cooperative (WFEC) systems may be verified with a transmission service request and associated studies.

Interconnection Facilities

The primary objective of this study is to identify attachment facilities. The requirements for interconnection consist of adding a new 345kV terminal in an existing EHV substation. This 345kV addition shall be constructed and maintained by OKGE. It is assumed that obtaining all necessary right-of-way for the line into the new OKGE 345kV substation facilities will be performed by the interconnection customer.

The total cost for OKGE to expand the sub by two rungs to the south, add two 345kV breakers, a line reactor, add a new 345kV terminal in Arcadia Substation, re-route the Seminole line into the new terminal, freeing up the existing terminal to be accessed by the gen-tie facility, and adding a line reactor at the interconnection facility, is estimated at \$13,486,359. This cost does not include building the 345kV line from the Customer substation into the new EHV Substation. The Customer is responsible for this 345kV line up to the point of interconnection. This cost does not include the Customer's 345-34.5kV substation and the cost estimate should be determined by the Customer.

This Facility Study does not guarantee the availability of transmission service necessary to deliver the additional generation to any specific point inside or outside the Southwest Power Pool (SPP) transmission system. The transmission network facilities may not be adequate to deliver the additional generation output to the transmission system. If the customer requests firm transmission service under the SPP Open Access Transmission Tariff at a future date, Network Upgrades or other new construction may be required to provide the service requested under the SPP OATT.

The costs of interconnecting the facility to the OKGE transmission system are listed in Table 1.

Short Circuit Fault Duty Evaluation

It is standard practice for OG&E to recommend replacing a circuit breaker when the current through the breaker for a fault exceeds 100% of its interrupting rating with re-closer de-rating applied, as determined by the ANSI/IEEE C37.5-1979, C37.010-1979 & C37.04-1979 breaker rating methods.

For this generator interconnection, no breakers were found to exceed their interrupting capability after the addition of the Customer’s 200 MW generation and related facilities. OG&E found no breakers that exceeded their interrupting capabilities on their system. Therefore, there is no short circuit upgrade costs associated with the Gen-2017-133 interconnection.

Table 1: Required Interconnection Network Upgrade Facilities

Facility	ESTIMATED COST (2023 DOLLARS)	Percentage Responsible
Lead Time	36 Months	
OKGE – Interconnection Facilities- Add one 345kV line terminals to Arcadia Substation. Dead end structures, line switch, line relaying, revenue metering including CTs and PTs	\$1,591,654	25%
OKGE – Network Upgrades at Arcadia sub, expand by two rungs, install two-345kV 3000A breaker, reroute Arcadia – Seminole line, line relaying, disconnect switches, and associated equipment.	\$5,489,336	25%
OKGE-Reactive Interconnection Facilities - Add line reactor, FIS, switch, relaying and protection	\$6,405,368	25%
OKGE - Right-of-Way for 345kV terminal addition	No Additional ROW	
Total Cost for Gen-2017-133	\$3,371,590	

Prepared by:
Chris Rich, P.E.
Transmission Planning Engineer
richcs@oge.com

March 09, 2023

Reviewed by:
Adam Snapp, P.E.
Manager- Transmission Planning
snapped@oge.com

March 15, 2023

Arcadia Substation

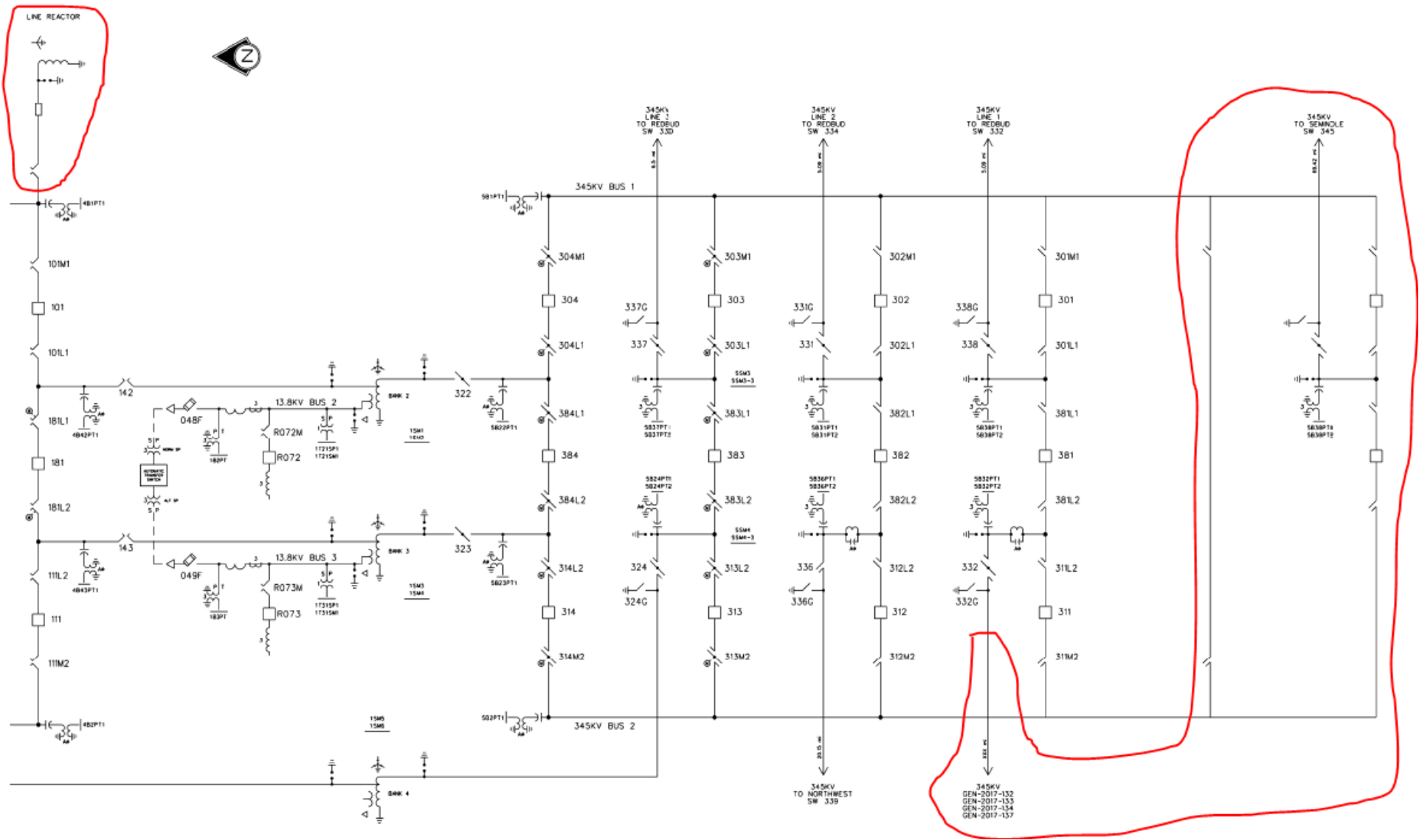



FACILITY STUDY

for

**IFS-2017-002-156853 Network Upgrades
For
DISIS-2017-002**

Arcadia to Louis Garber (OMPA) 138kV Rebuild
In Oklahoma County
Oklahoma

March 21, 2023

Chris Rich, P.E.
Transmission Planning Engineer
OG&E Electric Services

Summary

Pursuant to the tariff and at the request of the Southwest Power Pool (SPP), Oklahoma Gas and Electric (OG&E) performed the following Facility Study for Network Upgrades to satisfy the Facility Study Agreement executed by the requesting customer for SPP IFS-2017-002 for Network Upgrades. The request for interconnection was placed with SPP in accordance SPP's Open Access Transmission Tariff, which covers new generation interconnections on SPP's transmission system. The requirements for the Network Upgrade is to reconductor the 138kV line between Arcadia substation and Louis Garber substation(OMPA). The total cost for OKGE to complete these upgrades is \$6,000,000.

Table of Contents

Table of Contents	3
Introduction	4
Interconnection Facilities	5
Interconnection Costs	6
Diagram of Interconnection	7

Introduction

The Southwest Power Pool has requested a Facility Study for Network Upgrades within the service territory of OG&E Electric Services (OKGE) in Oklahoma County, Oklahoma. The proposed Network Upgrade Facilities are to re-conductor the 138kV line between Arcadia substation to Louis Garber Substation (OMPA) to facilitate a minimum of 313 MVA.

Network Constraints in the Southwest Public Service (SPS), OKGE and Western Farmers Electric Cooperative (WFEC) systems may be verified with a transmission service request and associated studies.

Other Network Constraints in the American Electric Power West (AEPW), Southwest Public Service (SPS), OKGE and Western Farmers Electric Cooperative (WFEC) systems may be verified with a transmission service request and associated studies.

Network Upgrade Facilities

The primary objective of this study is to identify network upgrades. The requirements for this Network Upgrade consist of installing a new 138kV line to replace the existing Arcadia to Louis Garber (OMPA) line on the OG&E transmission system to accommodate generator interconnection requests identified in SPP-GI DISIS-2017-002. These 138kV network upgrades shall be constructed and maintained by OKGE.

The total cost for the reconductor to facilitate 313 MVA on the 138kV Arcadia to Louis Garber (OMPA) is estimated at \$6,000,000.

This Facility Study does not guarantee the availability of transmission service necessary to deliver the additional generation to any specific point inside or outside the Southwest Power Pool (SPP) transmission system. The transmission network facilities may not be adequate to deliver the additional generation output to the transmission system. If the customer requests firm transmission service under the SPP Open Access Transmission Tariff at a future date, Network Upgrades or other new construction may be required to provide the service requested under the SPP OATT.

The costs of interconnecting the facility to the OKGE transmission system are listed in Table 1.

Short Circuit Fault Duty Evaluation

It is standard practice for OG&E to recommend replacing a circuit breaker when the current through the breaker for a fault exceeds 100% of its interrupting rating with re-closer de-rating applied, as determined by the ANSI/IEEE C37.5-1979, C37.010-1979 & C37.04-1979 breaker rating methods.

For this Network Upgrade, no breakers were found to exceed their interrupting capability after the upgrades to the line and related facilities. OG&E found no breakers that exceeded their interrupting capabilities on their system. Therefore, there is no short circuit upgrade costs associated with this DISIS-2017-002 Network Upgrade.

Table 1: Required Interconnection Network Upgrade Facilities

Facility	ESTIMATED COST (2023 DOLLARS)
Lead time	30 months
OKGE – Network Upgrades Install 4.77 miles of 138kV Transmission Line and associated relay and control equipment.	\$6,000,000.
Total	\$6,000,000.

Prepared by:
Chris Rich, PE
Staff Engineer, Transmission Planning
richcs@oge.com

March 21, 2023

Reviewed by:
Adam Snapp, P.E.
Manager - Transmission Planning
snappad@oge.com

March 27, 2023

Arcadia Sub to Louis Garber Sub

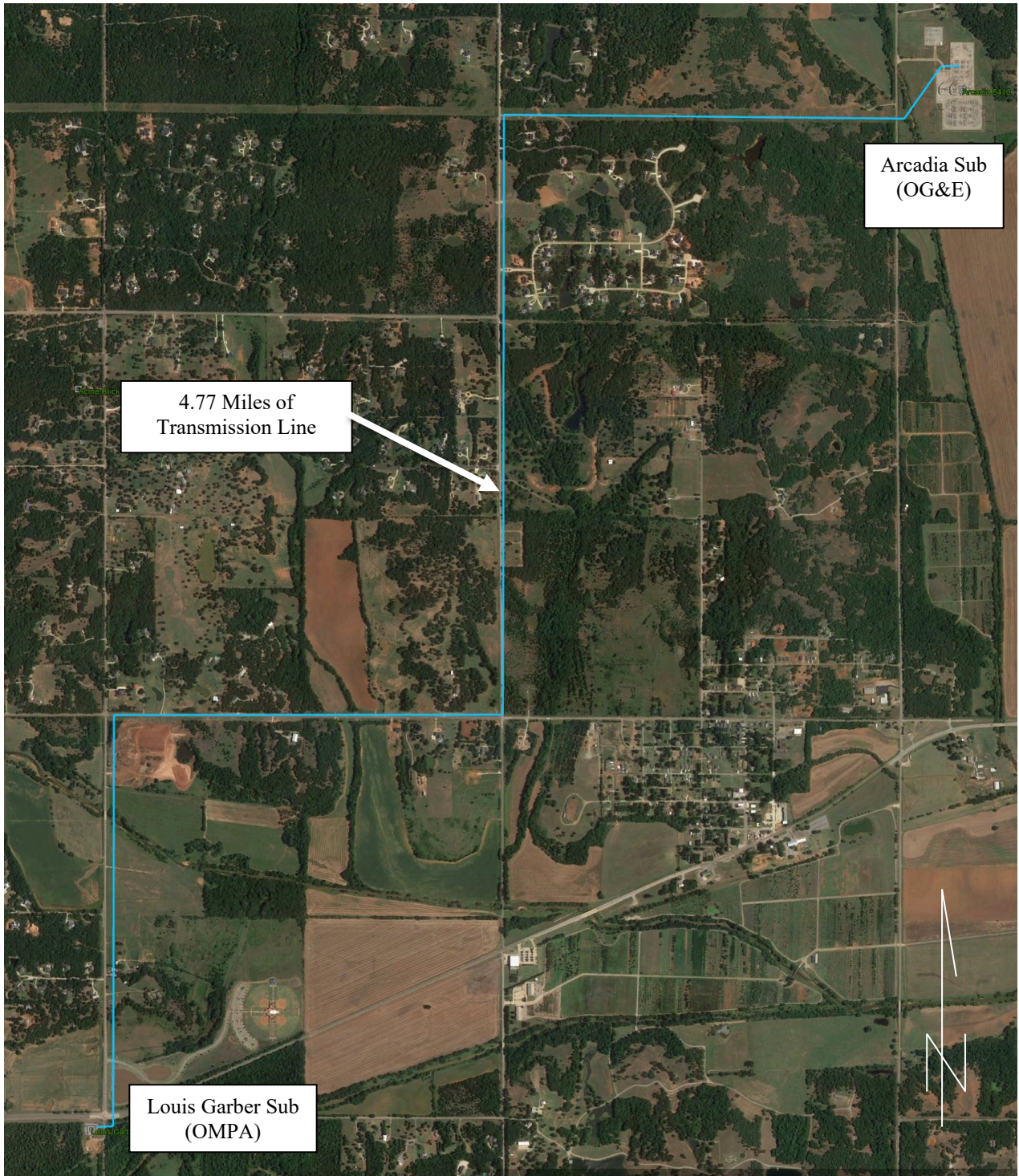



FACILITY STUDY

for

**IFS-2017-002-156854 Network Upgrades
For
DISIS-2017-002**

Arcadia to Jones-Kamo Line
In Oklahoma County
Oklahoma

March 21, 2023

Chris Rich, P.E.
Transmission Planning Engineer
OG&E Electric Services

Summary

Pursuant to the tariff and at the request of the Southwest Power Pool (SPP), Oklahoma Gas and Electric (OG&E) performed the following Facility Study for Network Upgrades to satisfy the Facility Study Agreement executed by the requesting customer for SPP IFS-2017-002 for Network Upgrades. The request for interconnection was placed with SPP in accordance SPP's Open Access Transmission Tariff, which covers new generation interconnections on SPP's transmission system. The requirements for the Network Upgrade is to re-conductor the Arcadia to Jones Kamo 138kV line. The total cost for OKGE to complete these upgrades is \$8,375,000.

Table of Contents

Table of Contents	3
Introduction	4
Interconnection Facilities	5
Interconnection Costs	6
One-Line diagram of Interconnection	7

Introduction

The Southwest Power Pool has requested a Facility Study for Network Upgrades within the service territory of OG&E Electric Services (OKGE) in Oklahoma County, Oklahoma. The proposed Network Upgrade Facilities are to re-conductor the Arcadia to Jones Kamo 138kV line to facilitate a minimum of 361 MVA.

Network Constraints in the Southwest Public Service (SPS), OKGE and Western Farmers Electric Cooperative (WFEC) systems may be verified with a transmission service request and associated studies.

Other Network Constraints in the American Electric Power West (AEPW), Southwest Public Service (SPS), OKGE and Western Farmers Electric Cooperative (WFEC) systems may be verified with a transmission service request and associated studies.

Network Upgrade Facilities

The primary objective of this study is to identify network upgrades. The requirements for this Network Upgrade consist of installing a new 138kV line to replace the existing Arcadia to Jones Kamo line on the OG&E transmission system to accommodate generator interconnection requests identified in SPP-GI DISIS-2017-002. These 138kV network upgrades shall be constructed and maintained by OKGE.

The total cost for the reconductor to facilitate 361 MVA on the 138kV Arcadia to Jones Kamo is estimated at \$8,375,000.

This Facility Study does not guarantee the availability of transmission service necessary to deliver the additional generation to any specific point inside or outside the Southwest Power Pool (SPP) transmission system. The transmission network facilities may not be adequate to deliver the additional generation output to the transmission system. If the customer requests firm transmission service under the SPP Open Access Transmission Tariff at a future date, Network Upgrades or other new construction may be required to provide the service requested under the SPP OATT.

The costs of interconnecting the facility to the OKGE transmission system are listed in Table 1.

Short Circuit Fault Duty Evaluation

It is standard practice for OG&E to recommend replacing a circuit breaker when the current through the breaker for a fault exceeds 100% of its interrupting rating with re-closer de-rating applied, as determined by the ANSI/IEEE C37.5-1979, C37.010-1979 & C37.04-1979 breaker rating methods.

For this Network Upgrade, no breakers were found to exceed their interrupting capability after the upgrades to the line and related facilities. OG&E found no breakers that exceeded their interrupting capabilities on their system. Therefore, there is no short circuit upgrade costs associated with this DISIS-2017-002 Network Upgrade.

Table 1: Required Interconnection Network Upgrade Facilities

Facility	ESTIMATED COST (2023 DOLLARS)
Lead Time	30 Months
OKGE – Network Upgrades Install 6.67 miles of 138kV Transmission Line and associated relay and control equipment.	\$8,375,000.
Total	\$8,375,000.

Prepared by:
Chris Rich, PE
Staff Engineer, Transmission Planning
richcs@oge.com

March 21, 2023

Reviewed by:
Adam Snapp, P.E.
Manager - Transmission Planning
snappad@oge.com

March 27, 2023

Arcadia Sub to Jones Kamo Sub

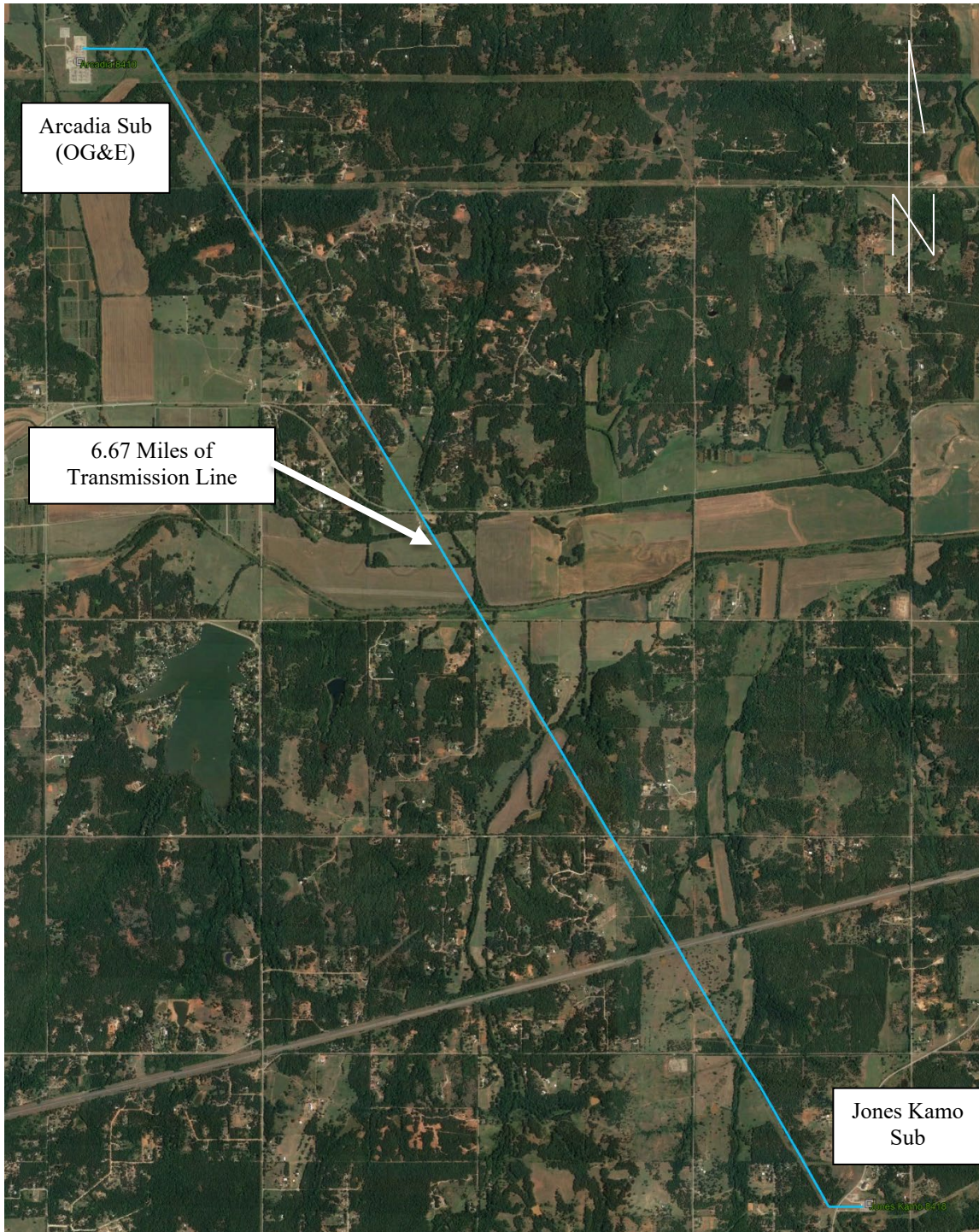



FACILITY STUDY

for

IFS-2017-002-156856 Network Upgrades For DISIS-2017-002

New 345kV/138kV Transformer at Arcadia Sub
In Oklahoma County
Oklahoma

March 21, 2023

Chris Rich, P.E.
Transmission Planning Engineer
OG&E Electric Services

Summary

Pursuant to the tariff and at the request of the Southwest Power Pool (SPP), Oklahoma Gas and Electric (OG&E) performed the following Facility Study for Network Upgrades to satisfy the Facility Study Agreement executed by the requesting customer for SPP IFS-2017-002 for Network Upgrades. The request for interconnection was placed with SPP in accordance SPP's Open Access Transmission Tariff, which covers new generation interconnections on SPP's transmission system. The requirements for the Network Upgrades are to add a new 345kV/138kV Transformer at Arcadia Sub, one 138kV breaker, two 345kV Breakers, associated switches, and reroute Redbud #1, Redbud #2 and Redbud #3 lines into new terminal positions at Arcadia substation. The total cost for OKGE to complete these upgrades is \$16,002,856.

Table of Contents

Table of Contents	3
Introduction	4
Interconnection Facilities	5
Interconnection Costs	6
One-Line diagram of Interconnection	7

Introduction

The Southwest Power Pool has requested a Facility Study for Network Upgrades within the service territory of OG&E Electric Services (OKGE) in Oklahoma County, Oklahoma. The proposed Network Upgrade Facilities are to add a new 345kV/138kV Transformer at Arcadia Sub, one 138kV breaker, two 345kV Breakers and reroute Redbud #1, Redbud #2 and Redbud #3 lines.

Network Constraints in the Southwest Public Service (SPS), OKGE and Western Farmers Electric Cooperative (WFEC) systems may be verified with a transmission service request and associated studies.

Other Network Constraints in the American Electric Power West (AEPW), Southwest Public Service (SPS), OKGE and Western Farmers Electric Cooperative (WFEC) systems may be verified with a transmission service request and associated studies.

Network Upgrade Facilities

The primary objective of this study is to identify network upgrades. The requirements for this Network Upgrade consist of installing a new 345kV/138kV Transformer at Arcadia Sub, one new 138kV breaker, two new 345kV Breakers, associated switches, relays, and protection equipment, as well as rerouting Redbud #1, Redbud #2 and Redbud #3 lines on the OG&E transmission system to accommodate generator interconnection requests identified in SPP-GI DISIS-2017-002. These 138kV and 345kV network upgrades shall be constructed and maintained by OKGE.

The total cost for adding a new 345kV/138kV Transformer at Arcadia Sub, one new 138kV breaker, two new 345kV Breakers, associated protection equipment and reroute Redbud #1, Redbud #2 and Redbud #3 lines into new terminals is estimated at \$16,002,856.

This facility study was performed under the assumption that the network upgrades associated with Gen 2017-132,133,134,137 are complete. If those projects drop out, the network upgrades associated with those GEN requests will need to be completed prior to the re-routing of the Redbud lines to allow for room to install this bus tie transformer. It is assumed that those costs would then be added to this facility study should those projects drop out of the GI que.

This Facility Study does not guarantee the availability of transmission service necessary to deliver the additional generation to any specific point inside or outside the Southwest Power Pool (SPP) transmission system. The transmission network facilities may not be adequate to deliver the additional generation output to the transmission system. If the customer requests firm transmission service under the SPP Open Access Transmission Tariff at a future date, Network Upgrades or other new construction may be required to provide the service requested under the SPP OATT.

The costs of interconnecting the facility to the OKGE transmission system are listed in Table 1.

Short Circuit Fault Duty Evaluation

It is standard practice for OG&E to recommend replacing a circuit breaker when the current through the breaker for a fault exceeds 100% of its interrupting rating with re-closer de-rating applied, as determined by the ANSI/IEEE C37.5-1979, C37.010-1979 & C37.04-1979 breaker rating methods.

For this Network Upgrade, no breakers were found to exceed their interrupting capability after installing the transformer and related facilities. OG&E found no breakers that exceeded their interrupting capabilities on their system. Therefore, there is no short circuit upgrade costs associated with this DISIS-2017-002 Network Upgrade.

Table 1: Required Interconnection Network Upgrade Facilities

Facility	ESTIMATED COST (2023 DOLLARS)
Lead Time	36 months
OKGE – Network Upgrades Install one 345kV/138kV Xfmr at Arcadia Sub, one 138kV Breaker, two 345kV Breakers, reroute Redbud #1, Redbud #2 and Redbud #3 lines, and install/update associated relay, control and protection equipment.	\$16,002,856
Total	\$16,002,856

Prepared by:
Chris Rich, PE
Staff Engineer, Transmission Planning
richcs@oge.com

March 21, 2023

Reviewed by:
Adam Snapp, P.E.
Manager - Transmission Planning
snappad@oge.com

March 27, 2023

Arcadia 345kV Sub

